

CONTRACTOR SUPPLY PRODUCTS

L

Index

Product	Page
Pipe and Fittings	L1, L2
Geotextile Filter Fabrics & Grids	L3
Highway Grates, Covers & Hatches	L4
Polydrain	L5
Residential On-site Sewage Disposal Products	L6
Concrete Forms and Accessories	L7 - L10
Fabricated Reinforcing Bar	L11

Binghamton Precast & Supply is well known to many contractors as a competitive source for various construction supplies.

Products Include:

- Concrete forms and accessories
- Pipe and fittings
- Geotextile fabrics and grid
- Highway grates, covers and hatches
- Polydrain surface drainage systems
- On-site sewage disposal products
- Fabricated reinforcing bar for on site cost in place construction

Binghamton Precast & Supply is a full service company providing the products that construction needs.

Binghamton



**Precast
& Supply**

18 Phelps Street, Binghamton, NY 13901

Fax: (607) 722-0496

Email: sales@binghamtonprecast.com

Phone: (607) 722-0334

Toll Free: 1-800-336-1474

Website: www.binghamtonprecast.com

L1

Pipe and Fittings

Rubber Couplings

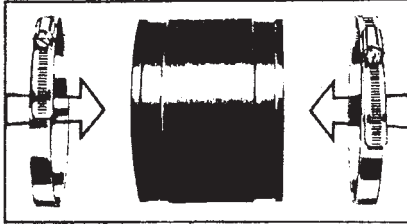

Sizes: 1-1/2" x 1-1/2" through 15" x 15"

Types: CIP, PVC, Copper, Steel or Lead to CIP, PVC Copper, Steel or Lead
Clay to Clay
Clay to Cast Iron or Plastic

Multi-Cement

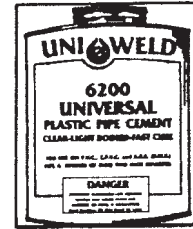

1/2 Pint
Quart

Pipe

Our pipe product lines include complete product offerings. For sprinkler systems, irrigation systems, leach line piping, culvert and drainage piping and more. Select from our inventory of pipes listed below.

Prices may increase or decrease on a weekly basis. Please check for current prices.

P = Perforated
S = Solid

SIZE	SMOOTHWALL S&D PIPE		SEWER & DRAIN				SDR-35 SEWER PIPE	SCD-40 D.W.V.	AGRI-FLOW CORRUGATED UNDERDRAIN	POLYETHYLENE CULVERT PIPE		
	P/ft	S/ft	P/ft	S/ft	1/4 Pallet 600' Per ft. Price	1/2 Pallet Savings	S/ft	S/ft	P/ft	S/ft	S/ft	
1 1/2"	—	—	—	—	—	—	—	—	—	—	—	—
2"	—	—	—	—	—	—	—	—	—	—	—	—
3"	—	—	—	—	—	—	—	—	—	—	—	—
4"	—	—	—	—	—	—	—	—	—	—	—	—
6"	—	—	—	—	—	—	—	—	—	—	—	—
8"	—	—	—	—	—	—	—	—	AVAIL.	—	—	—
10"	—	—	—	—	—	—	—	—	AVAIL.	—	—	—
12"	—	—	—	—	—	—	—	—	AVAIL.	—	—	—
15"	—	—	—	—	—	—	—	—	—	—	—	—
Length	10'		10'				13'	10'	100' or 250'roll		20'	

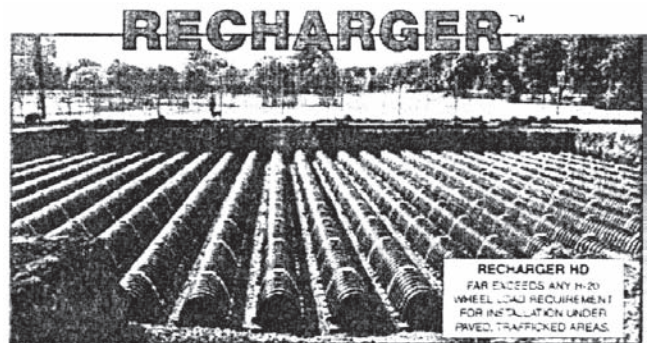

18 Phelps Street, Binghamton, NY 13901

Fax: (607) 722-0496

Email: sales@binghamtonprecast.com

Phone: (607) 722-0334

Toll Free: 1-800-336-1474

Website: www.binghamtonprecast.com

Binghamton





















Precast & Supply









Pipe and Fittings

L2





SDR-35 Fittings

Item	Size	Ctn Qty	Item	Size	Ctn Qty	Item	Size	Ctn Qty
COUPLING REPAIR 	4	36	90° ELL 	4	20	FEMALE ADAPTER 	4	20
	6	12		6	6		6	12
	8	2		8	2		8	12
TEE 	4	15	45° ELL 	4	20	CAP 3034 	4	40
	6x6x4	5		6	8		6	25
	8x8x6	4		8	6		8	5
WYE 	4	10	45° ELL 	4	24	G 	4	30
	6x6x4	4		6	8		6	24
	8x8x4	2		8	8		5	24
MALE TH-HEAD PLUG 	4	60	22 1/2° ELL 	4	15	SPIGCT PLUG 	4	30
	6	30		6	10		6	24
				8	8		8	5
WYE 	4	10	22 1/2° ELL 	4	15	INCREASER 	4x6	20
	6x6x4	4		6	10		6x8	6
	8x8x4	2		8	8		8x10	1
WYE 	4	10	22 1/2° ELL 	4	15	INCREASER 	10x12	1
	6x6x4	4		6	10			
	8x8x4	2		8	8			











SDR-40 Fittings

Item	Size	Ctn Qty	Item	Size	Ctn Qty	Item	Size	Ctn Qty
COUPLING 	1 1/2	25	CLEANOUT PLUG 	1 1/2	120	90° ELBOW 	1 1/2	25
	2	25		3	30		2	25
	3	60		4	30		3	30
	4	45		6	10		4	10
	6	10		6	10		6	5
FLUSH BUSHING 	2x1 1/2	65	22.5° ELBOW 	1 1/2	30	WYE 	1 1/2	55
	3x2	40		2	40		3	10
	4x3	30		3	30		4	5
	6x4	25		4	15		6	2
				6	10			
FEMALE ADAPTER 	1 1/2	25	45° ELBOW 	1 1/2	40	SANITARY TEE 	1 1/2	25
	2	20		2	25		2	10
	3	10		3	20		3	15
	4	10		4	10		4	12
	6	10		6	5		6	3

Corrugated Fittings

ITEM	SIZE	CTN. QTY.
Internal Coupler 	4" 6"	50 20
Split Coupler 	10" 12" 15"	5 5 5
90° Elbow 	4" 6"	25 5
WYE 	4" 6"	10 5
Tee 	4" 6"	25 5

Sewer and Drain Fittings

ITEM	SIZE	CTN. QTY.
Coupling HxH 	4" 6"	40 —
Bushings SPGxH 	6"x4"	18
90° 1/4 Bend Long HxH Turn 	4" 6"	30 —
45° 1/8 Bend HxH 	4" 6"	50 —
22 1/2° 1/16 Bend HxH 	4" 6"	25 —
45° Wye HxHxH 	4" 6"	22 —
Tee HxHxH 	4" 6"	25 —
Cross HxHxH 	4"	12
CAP H 	4" 6"	80 —
Downspout Adapter DSxH 	3"x4"x4"	25
Drain Grate SPG 	4"	30

Binghamton



**Precast
& Supply**

18 Phelps Street, Binghamton, NY 13901

Fax: (607) 722-0496

Email: sales@binghamtonprecast.com

Phone: (607) 722-0334

Toll Free: 1-800-336-1474

Website: www.binghamtonprecast.com

L3

Geotextile Filter Fabrics & Grids

Silt Fence

The fence is designed to stop sedimentation runoff and erosion on construction sites. For added convenience, the silt fence comes pre-assembled with pre-attached oak stakes.

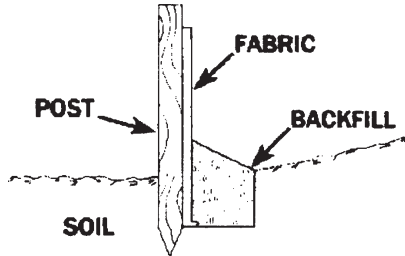

Prefabricated Silt Fence with Pockets

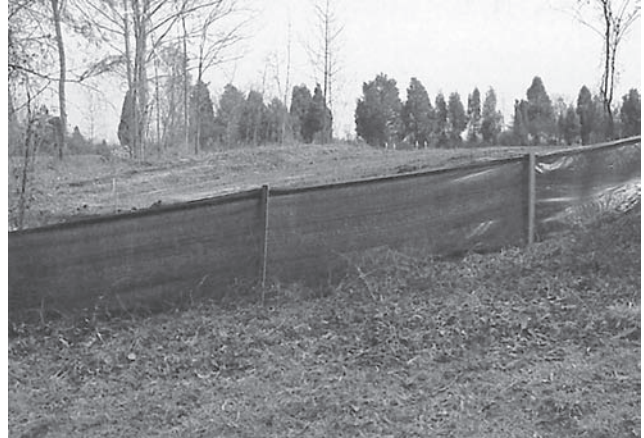

Silt Geotextiles for Paving

As a separator in paving construction, fabrics prevent the development of "alligator cracks," potholds and ruts, and enhance the load-bearing capacity of any paved surface.



Silt Geotextiles for Septic Systems

Used in drainage, landscaping and septic projects, geotextiles preserve the capacity of leach fields, while spunbonded fibers resist acids, alkalis and micro-organisms.

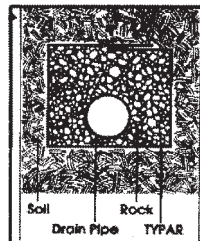

Soil Stabilization Grids

These high performance materials consist of an open polymer grid structure specifically designed to interact with the soil in a wide variety of civil engineering applications.

18 Phelps Street, Binghamton, NY 13901

Fax: (607) 722-0496

Email: sales@binghamtonprecast.com

Phone: (607) 722-0334

Toll Free: 1-800-336-1474

Website: www.binghamtonprecast.com

Binghamton



**Precast
& Supply**

Highway Grates, Covers & Hatches

L4

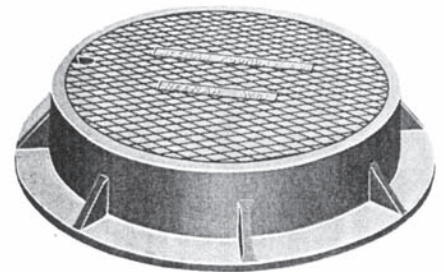
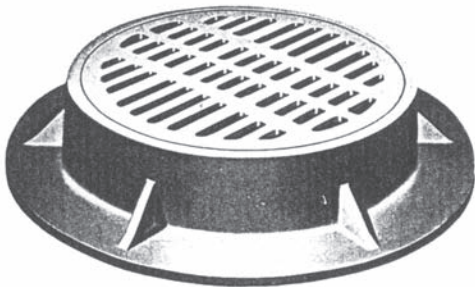
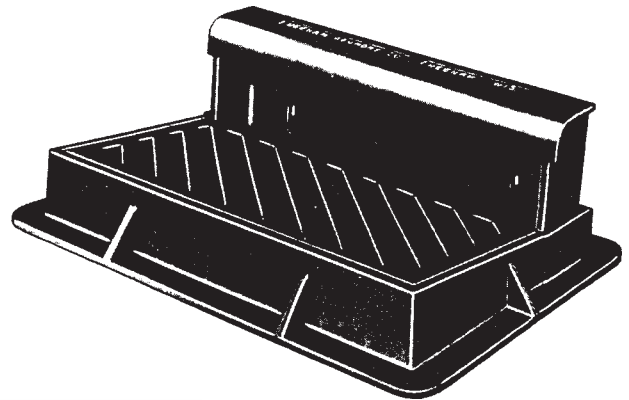
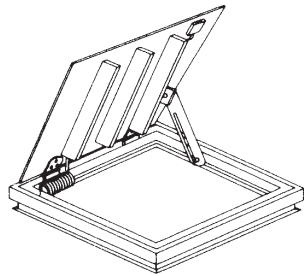
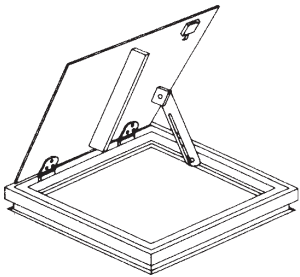
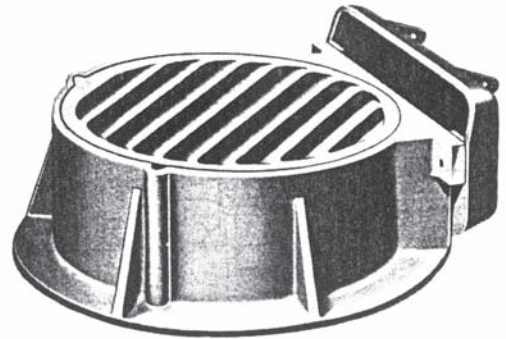
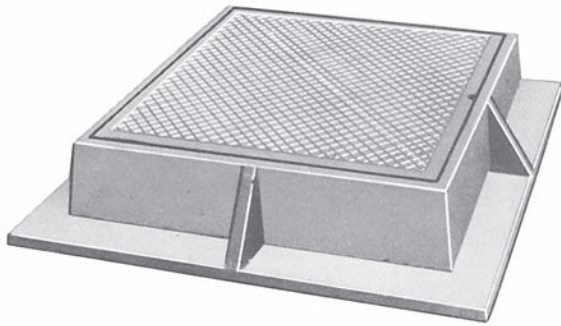

High Volume, High Value

From the surface, one diamond plate pattern looks much the same as the other, but Binghamton Precast & Supply has gone beneath the surface and developed a large, easily accessible in-stock selection of castings, hatches and materials that are ready-for-delivery. Quality materials and BP&S rapid sales response will give added value to your project.

Binghamton



**Precast
& Supply**

18 Phelps Street, Binghamton, NY 13901

Fax: (607) 722-0496

Email: sales@binghamtonprecast.com

Phone: (607) 722-0334

Toll Free: 1-800-336-1474

Website: www.binghamtonprecast.com

Typical PolyDrain System

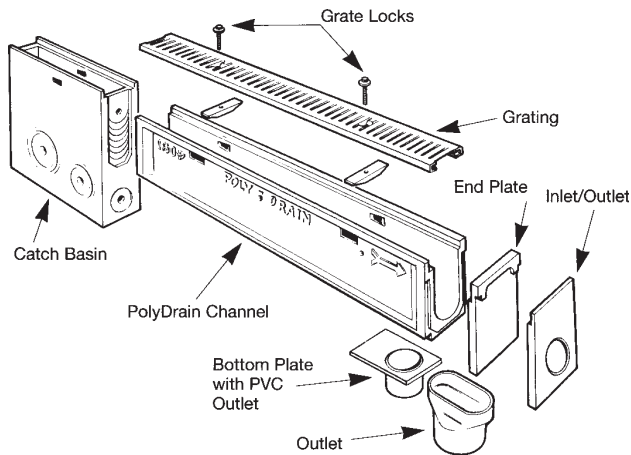

Pre-Sloped Radius Channels

Standard PolyDrain channels have a built-in 0.6% slope with a smooth radius bottom and a narrow cross section. These features provide excellent hydraulic efficiency and when hydraulically loaded can achieve flow velocities of 3.5 feet per second.

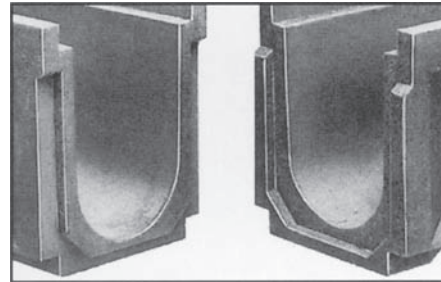
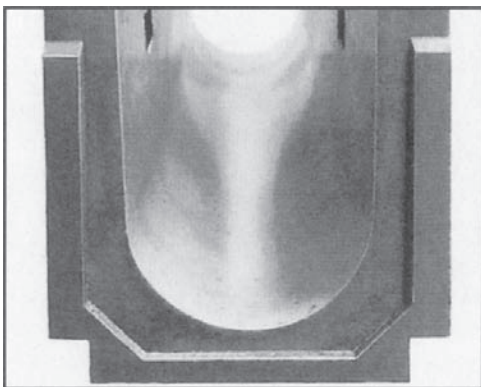

Interlocking Joints

PolyDrain channels have interlocking tongue-and-groove joints that serve two important functions. First they aid in Maintaining proper channel alignment during the pour. Second, they assist in securing channel connections to prevent fluid migration out of the system. ABT maintains a line of sealants that can be applied to channels when a sealed system is required.

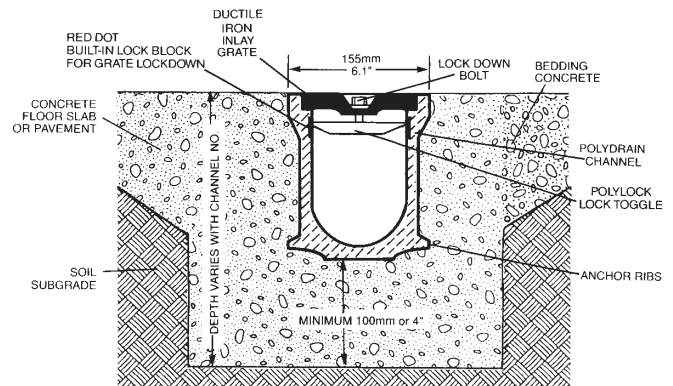

18 Phelps Street, Binghamton, NY 13901

Fax: (607) 722-0496

Email: sales@binghamtonprecast.com

Phone: (607) 722-0334

Toll Free: 1-800-336-1474

Website: www.binghamtonprecast.com

Binghamton



**Precast
& Supply**

Residential On-site Sewage Disposal Products

L6

Goulds Pump

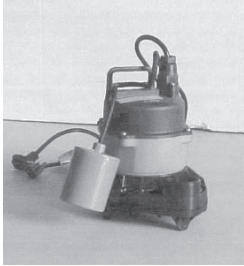

- Various styles & sizes
- Full line of accessories

Syphon

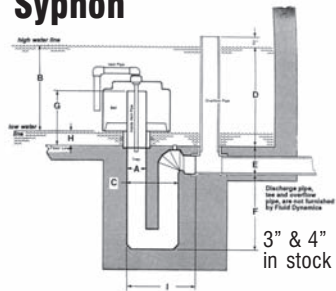

- No moving parts to wear out
- Dosage determined by size of chamber
- Call our sales department for assistance

Alarm



- Tank Alarm I** - Alarm System (indoor)
 - Tank Alarm II** - Alarm System (indoor & outdoor)
- Horn and light warn of high or low liquid levels.*

HDPE Recycled Plastic Manhole Adjusting Rings

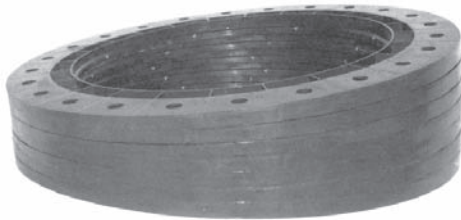

Easily adjusts to any grade & slope.

Speed Leveler

TUF-TITE

Made of tough, high-density polyethylene. Tuf-Tite speed levelers provide maximum flow control.

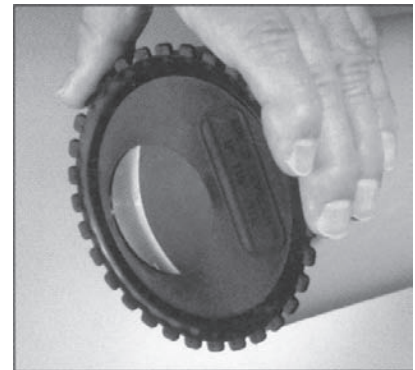

Zabel Filter



The **Zabel Filter** provides an effective mean of preventing solids from clogging drain fields by removing 68% of the solids in the effluent.

**Broome County
Approved!**

Bio-Jet 7



Bio-Jet 7 is formulated to replenish and supplement bacteria populations and bacterial functions in septic tanks, wastewater treatment plants, ponds and lagoons. Overcomes

problems such as odors, plugged drain fields and excessive solid accumulation.

Per gal. & 5 gal. pail.

J-1 Chlorinator



Designed to provide positive flow through contact with chlorine tablets, the convenient

J-1 Chlorinator avoids over-saturation and because it takes any brand of 3" tablet, eliminates timely searching for under-sized tablets.

Binghamton



**Precast
& Supply**

18 Phelps Street, Binghamton, NY 13901

Fax: (607) 722-0496

Email: sales@binghamtonprecast.com

Phone: (607) 722-0334

Toll Free: 1-800-336-1474

Website: www.binghamtonprecast.com

L7

Concrete Forms and Accessories

– ALUMINUM FORMING SYSTEM –



NOMINAL/FULL WALL TIES STANDARD BREAK BACK

ULTIMATE LOAD (LBS.) 7,000

ALUM. NOM./FULL

4" thru 24" stock items.

TWO COMBO

ALUM. NOM./FULL

6-8"	8-10"	10-12"	12-14"	14-16"
16-18"	18-20"	20-22"	22-24"	

THREE COMBO

ALUM. NOM./FULL

6-8-10"	8-10-12"	10-12-14"	12-14-16"
14-16-18"	16-18-20"	18-20-22"	20-22-24"

Over 24" built upon request.

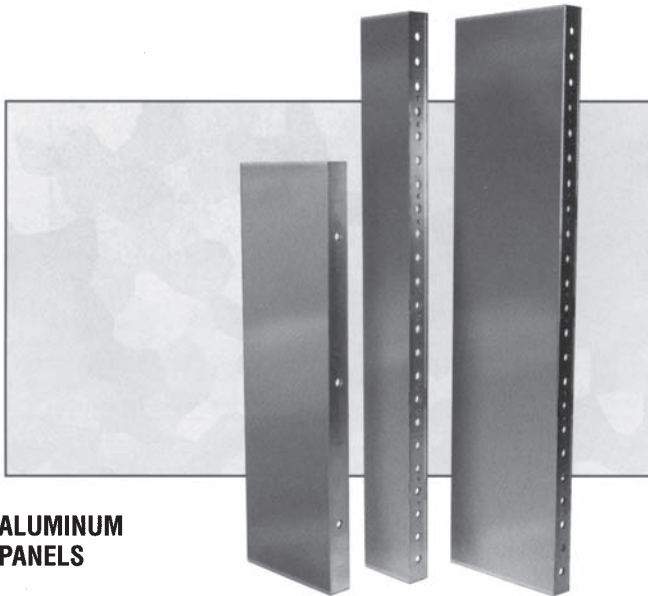

ALUMINUM PANELS

1" thru 36" in width.
12" thru 108" in height.



1" BREAK BACK TIES

ULTIMATE LOAD (LBS.) 7,000

ALUM. NOM.

6" 8" 10" 12" 14" 16" 18" 20" 22" 24"

ALUM. FULL

6" 8" 10" 12" 14" 16" 18" 20" 22" 24"

Over 24" built upon request.



BRICK FACE TIES

ULTIMATE LOAD (LBS.) 7,000

NOMINAL BRICK FACE 8"

NOMINAL BRICK FACE 10"

BLUE EDGE FOR IDENTIFICATION

FULL BRICK FACE 8"

FULL BRICK FACE 10"

YELLOW EDGE FOR IDENTIFICATION



BASE TIES

ULTIMATE LOAD (LBS.) 3,000

ALUM. NOM. BASE

6" 8" 10" 12" 14" 16" 18" 20"

ALUM FULL BASE

6" 8" 10" 12" 14" 16" 18" 20"

18 Phelps Street, Binghamton, NY 13901

Fax: (607) 722-0496

Email: sales@binghamtonprecast.com

Phone: (607) 722-0334

Toll Free: 1-800-336-1474

Website: www.binghamtonprecast.com

Binghamton



Precast & Supply

– ALUMINUM FORMING SYSTEM – Accessories



CAP CLIP

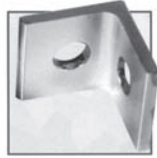

90° ANGLE CLIP



45° ANGLE PIN



2X4 SMOOTH/
BRICK FACE
2X6 SMOOTH/
BRICK FACE

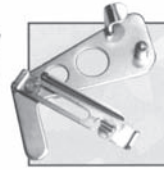

2X4 SURE-TITE
WALER

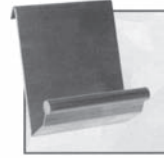

PIC-EZ

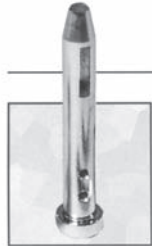

COMBO FILLER
PIN



FLAT HEAD



ROUND HEAD PIN



BASE PIN

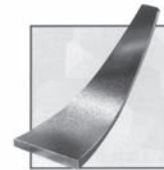

CURVED HARD
WEDGE

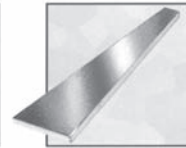

FLAT HARD
WEDGE

– STEEL/PLYWOOD FORMING SYSTEM – Accessories



STEELPLY SYSM.
BASE TIE WEDGE



STEELPLY SYSM.
WEDGE BOLT
SHORT



STEELPLY SYSM.
WEDGE BOLT STD.



STEELPLY SYSM.
WEDGE BOLT
LONG



STEELPLY SYSM.
WEDGE BOLT ADJ.



STEELPLY SYSM.
S-WEDGE



CURBING WEDGE



1/2" PLYWOOD
POP RIVETS



WALER BRACKET

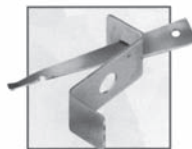

Z-TIE HOLDER



WALER TIES



STRONG BACK/
STIFF BACK TIE



TURNBUCKLE
FORM ALIGNER

Binghamton



**Precast
& Supply**

18 Phelps Street, Binghamton, NY 13901

Fax: (607) 722-0496

Email: sales@binghamtonprecast.com

Phone: (607) 722-0334

Toll Free: 1-800-336-1474

Website: www.binghamtonprecast.com

– STEEL/PLYWOOD FORMING SYSTEM –

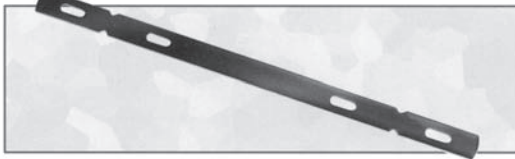

WALL TIES
X-FLAT STANDARD
1/4" BREAK BACK-ROLLED EDGES
 ULTIMATE LOAD (LBS.) 6,000
 4" thru 48" stock items.
 Over 48" built upon request.



HEAVY DUTY X-FLAT
1/4" BREAK BACK-ROLLED EDGES
 ULTIMATE LOAD (LBS.) 7,000
 4" thru 48" stock items.
 Over 48" built upon request.



STANDARD & HEAVY DUTY LOOP TIES
STD. LOOP PANEL
 6" 8" 10" 12" 14" 16" 18" 20" 22" 24"



BASE TIES
 ULTIMATE LOAD (LBS.) 3,000
 6" thru 24" stock items.

H.D. LOOP PANEL
 6" 8" 10" 12" 14" 16" 18" 20" 22" 24"
 Over 24" built upon request.



(M) - TYPE TIE
 ULTIMATE LOAD (LBS.) 7,000
 6" 8" 10" 12" 14" 16"
 Over 16" built upon request.

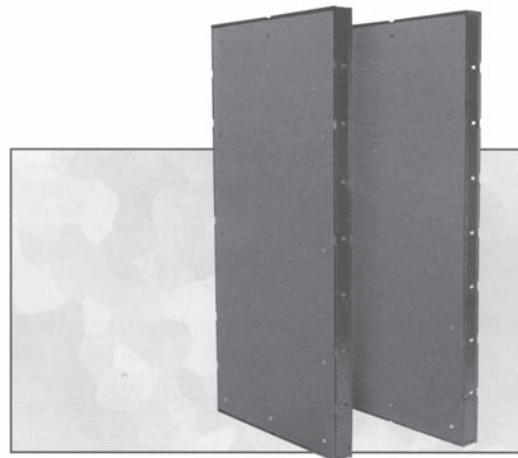

HAND-SET PANELS AND FILLERS
 All Panels Available in 3", 4", 5", 6", 8", 9" heights.
 1" thru 24" in width.

18 Phelps Street, Binghamton, NY 13901

Fax: (607) 722-0496

Email: sales@binghamtonprecast.com

Phone: (607) 722-0334

Toll Free: 1-800-336-1474

Website: www.binghamtonprecast.com

Binghamton



**Precast
& Supply**

– STEEL/PLYWOOD FORMING SYSTEM –

Contractor Accessories



A. FAST-LOCK

ULTIMATE LOAD (LBS.) 3,000
6" 8" 10" 12" 14" 16"
COMPATIBLE WITH DURAFORM
ONE LOCK SYSTEM.
Additional sizes upon request.

B. EMI ECONOMY FORMING TIE

4" 6" 8" 10" 12" 14"
16" 18" 20" 22" 24"
COMPATIBLE WITH THE EFCO
FORMING SYSTEM.
WALL SIZE 1/2" BREAK BACK
WALL SIZE 1" BREAK BACK
Additional sizes upon request.

C. EMI EB TIE

6" 8" 10" 12" 14"
16" 18" 20" 22" 24"
COMPATIBLE WITH THE BURKE
ALUMINUM HAND-SET FORM.
Additional sizes upon request.

D. EMI "U" TIE

6" 8" 10" 12"
COMPATIBLE WITH THE UNI-FORM
FORMING SYSTEM.
Additional sizes upon request.

E. SNAP TIE

(4-3/4 END) SNAP TIE
6" 8" 10" 12" 14"
16" 18" 20" 22" 24"

(8-1/4 END) SNAP TIE
6" 8" 10" 12" 14"
16" 18" 20" 22" 24"
Additional sizes upon request.

F. HEAVY WEDGE

G. RESIDENTIAL WALL TIES
RESIDENTIAL
6" 8" 10" 12"
Additional sizes upon request.

H. ANCHOR BOLTS

ANCHOR BOLTS
3/8x6" 3/8x8" 3/8x10"
3/8x12" 1/2x6" 1/2x8"
1/2x10" 1/2x12" 1/2x16"
5/8", 3/4", 1" Available upon request.

I. ANCHOR CLIPS

14 3/4" length

J. PLANK PROTECTOR

2"x8" PLANK PROTECTOR
2"x10" PLANK PROTECTOR
2"x12" PLANK PROTECTOR
Protects the ends of scaffold planks
from splitting.

K. SCAFFOLD TIE

5" 9"

L. STEEL STAKES

RND NAIL 3/4x12" RND NAIL 3/4x18"
RND NAIL 3/4x24" RND NAIL 3/4x30"
RND NAIL 3/4x36" RND NAIL 3/4x42"
RND NAIL 3/4x48"

RND NAIL 7/8x18" RND NAIL 7/8x24"
RND NAIL 7/8x30" RND NAIL 7/8x36"
RND NAIL 7/8x42" RND NAIL 7/8x48"

FLAT NAIL 12" FLAT NAIL 18"
FLAT NAIL 24" FLAT NAIL 30"
FLAT NAIL 36" FLAT NAIL 42"
FLAT NAIL 48"

M. CONSTRUCTION NAILS

DUPLEX 8DH
DUPLEX 16DH
COMMON 16
COMMON 6
COMMON 8
FLUTED 2 1/2"
FLUTED 1 1/2"

N. HAND TWIST TOOL

O. BLACK ANNEALED BAR TIES 16 GAUGE

5" 6" 7" 8" 10"
Other guages and sizes available
upon request.

P. REBAR TIE WIRE

Q. IDEAL REAL

R. FOUNDATION VENT

This complete ventilation system
is ready to install in a self-contained
frame for ease in adapting to any
wall condition.

S. ALUMINUM CHUTES

8", 12", 16" and 20"

T. 5' TRUNK

U. STANDARD 11"

V. STEEL REINFORCED SAFETY CAP

COMPLIES WITH OSHA 701(B).
APPROVED BY CALIFORNIA OSHA.
APPROVAL #01705-AG. "REBAR
GUARDED IN ACCORDANCE WITH
SECTIONS 1712 OF THE CALIFORNIA
CODE OF REGULATIONS SHOULD BE
DETERMINED TO BE IN COMPLIANCE
WITH 1926-701 (B)."

W. REBAR SAFETY CAP

Binghamton



**Precast
& Supply**

18 Phelps Street, Binghamton, NY 13901

Fax: (607) 722-0496

Email: sales@binghamtonprecast.com

Phone: (607) 722-0334

Toll Free: 1-800-336-1474

Website: www.binghamtonprecast.com

L11

Fabricated Reinforcing Bar

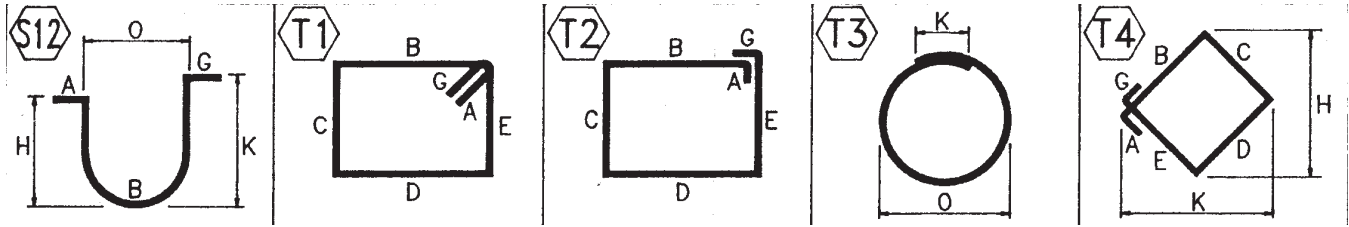

Binghamton Precast and Supply's automated shear lines, benders and other specialized equipment ensure reinforcing steel is cut, bent and shaped to exacting tolerances for projects of every degree of complexity.

As an integral part of Binghamton Precast and Supply's commitment to client support, the skilled craftsmanship in the fabricating shops ensure customer specifications are matched... the first time, every time.

Services Include:

- Detailed Estimates
- Erection Drawings
- On Site Installation
- Preassembled Box Cages

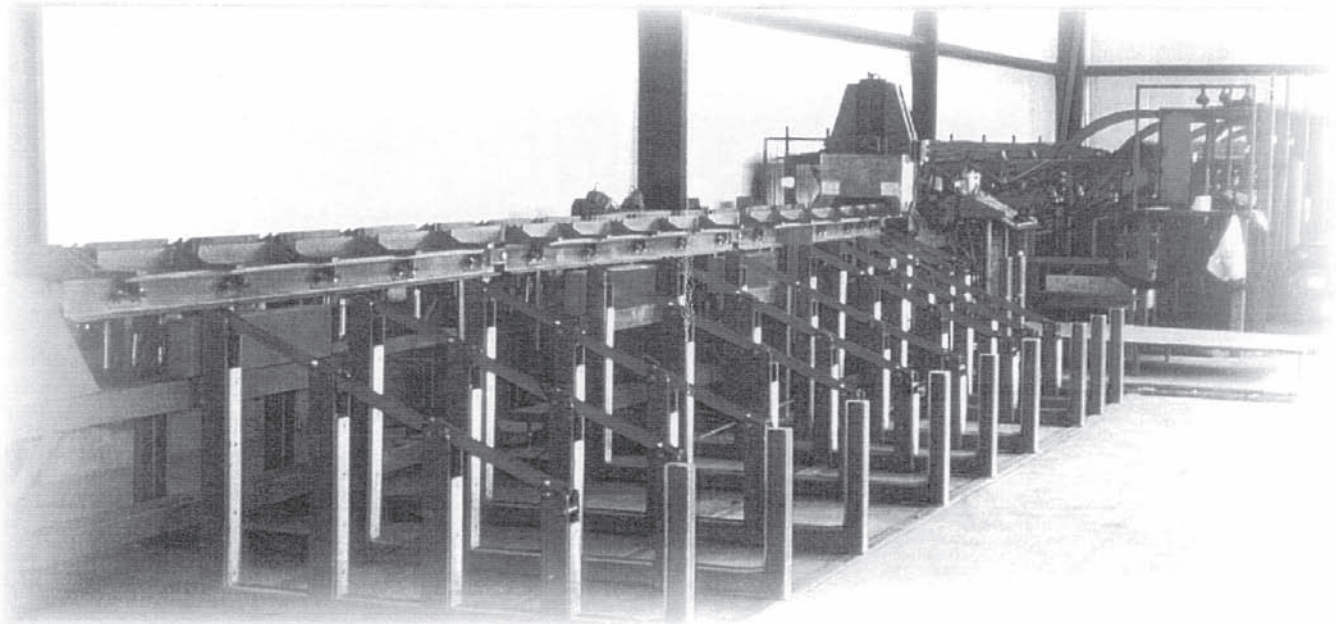

18 Phelps Street, Binghamton, NY 13901

Fax: (607) 722-0496

Email: sales@binghamtonprecast.com

Phone: (607) 722-0334

Toll Free: 1-800-336-1474

Website: www.binghamtonprecast.com

Binghamton



**Precast
& Supply**